

# THORN

LIGHTING



# ALTIS

Controlled floodlighting for every need

# HIGH LUMINANCE. LOW GLARE.

As a powerful and flexible LED floodlight for wide-ranging sports and high column area lighting applications, Altis offers numerous CCT/CRI/TLCI (4000K and 5700K, CRI from 70 to 90+ and TLCI up to 90+) as well as color changing configuration options (RGBW and Balanced White). In addition to flicker-free operation for HDTV broadcasting, it also provides mixed optics. Thanks to its tiltable LED modules, it enables installation design optimisation with a minimum number of floodlights.



Stadium  
& arenas



Recreational  
sports



Multi-sports  
halls



Swimming  
pools



Transportation &  
industrial areas



Façades



Light shows



# MODULAR AND HIGHLY FLEXIBLE

Altis is available in 1, 2 or 3-module versions, allowing for a variety of optical configurations and installation options – from horizontal for reduced obtrusive light (Ocd at 90°) to tiltable (+/-60°) for sports applications. Each module can be equipped with a different optic. Tilting enables lighting design optimisation with fewer floodlights and greatly reduces windage.

## LIGHT WHERE YOU NEED IT

A floodlight should precisely illuminate the intended area. It is important that scattered light reaching neighbouring buildings is minimal and that players and spectators are not dazzled. Altis can be equipped for different light distributions, including asymmetric for area and symmetric for sports applications. Asymmetrically, it focusses the light forward at 0° tilt with a defined cut-off to reduce artificial sky glow, glare and intrusive light.



3 LED modules (396L)



2 LED modules (264L LB)

## HIGH PERFORMANCE

Whether large stadium, recreational field or area floodlighting, the compact gearbox delivers high performance in all types of installations. Its improved lifetime also makes it an attractive retrofit solution.



Gearbox

## SYMMETRICAL LIGHTING DISTRIBUTIONS

NB / MB / WB

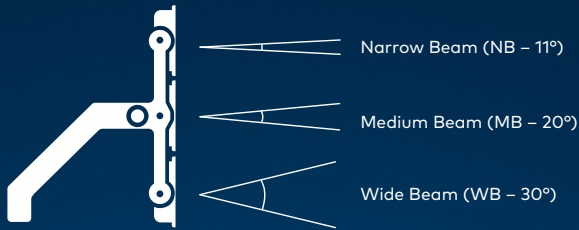

## ELLIPTICAL LIGHTING DISTRIBUTION

EB

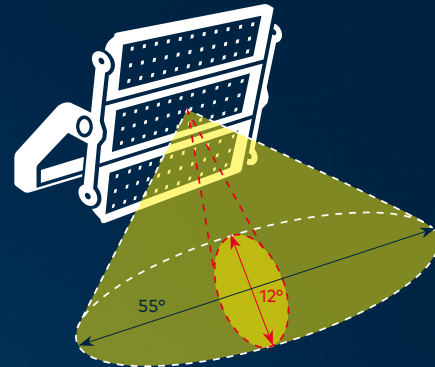

## ASYMMETRICAL LIGHTING DISTRIBUTIONS

A4 / A5 / A6 / A6-I / CB

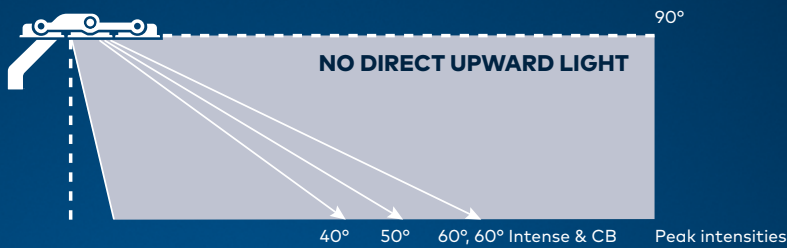

## ELIMINATE UPWARD LIGHT RISK

Now with two modules

Until now, applications calling for first-rate spill light control and a ULOR of 0% were best served with the 3-module version. A new dedicated 2-module version, which can be installed post-top and from 0° to 15° tilt, now offers the same protection.

1 LED module (132L)

2 LED modules (264L)



# LIGHT JUST RIGHT FOR TV

At stadiums that host televised events, lighting specifications for HD, 4K TV and super-slow motion capabilities are key. Altis scores 90+ on the TLCI (Television Lighting Consistency Index), which broadcasters use to evaluate the performance of lighting for television. It provides to the camera the real color of the athletes or of the illuminated scene to optimise TV viewing.

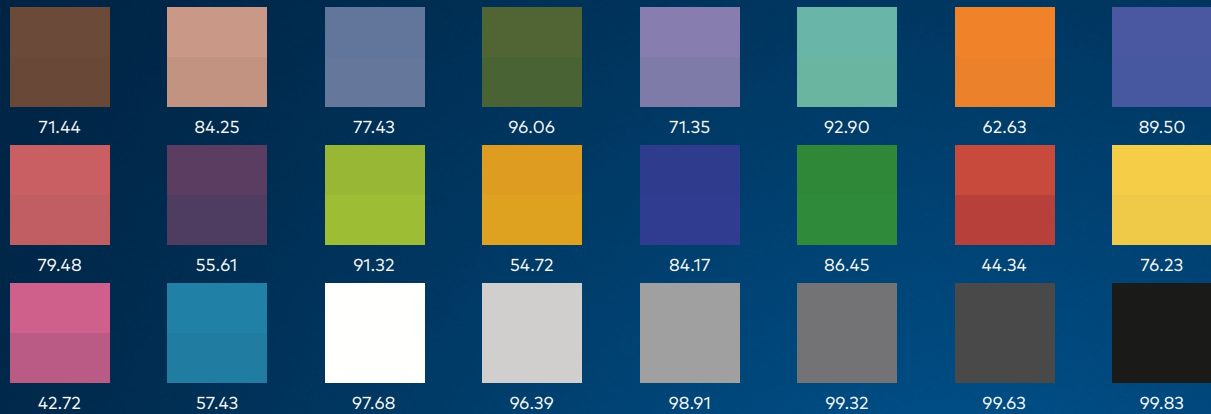

## TLCI COLOUR CHART

The Television Lighting Consistency Index (TLCI) is used to evaluate light quality. It measures the spectral power distribution of a luminaire using a spectroradiometer, analyses its television performance, and assigns a colour value on a scale from 0 to 100. These are displayed vis-à-vis the reference values.

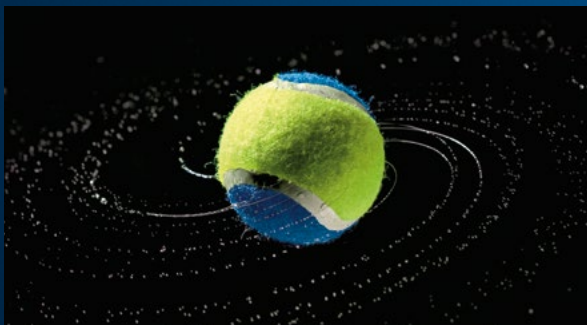

## BEST-IN-CLASS LIGHT

With our embarked electronic providing gearboxes with a flicker factor <1% as a standard, Altis offers slow motion broadcasting up to 1000 fps, to enable TV broadcasters to film super-slow-motion replays with no visible flicker.

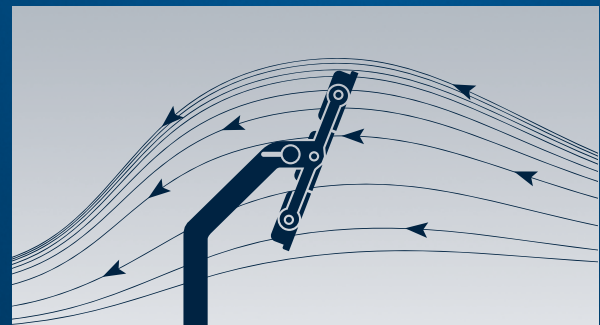

## MINIMISING WINDAGE

Windage is the force generated by wind on an object such a floodlight. Altis greatly minimises windage through combined frame and modules tilting up to 70°. Thorn floodlights are tested to optimise tilting and keep windage to a minimum.

# PLAY WITH COLOURS

Altis RGBW and Balanced White now complete the Altis range with the option of colour and colour temperature changing.

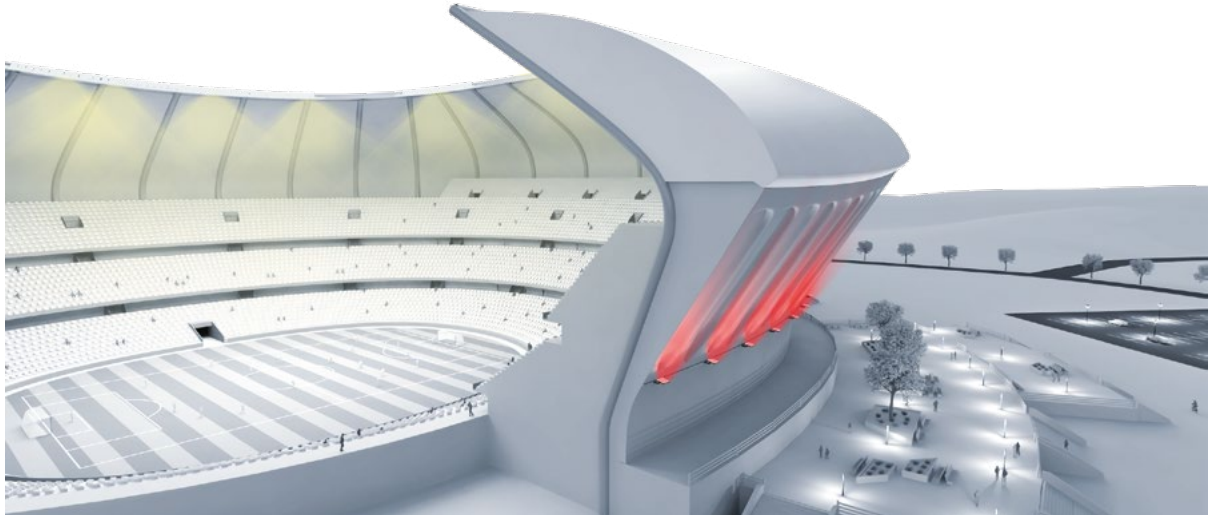

## CREATE A UNIQUE IDENTITY

Turn your stadium into a space of experience by offering colourful animations with the Altis RGBW option. You can light up the roof, highlight the facade or even create roof lighting with customised colour patterns. Spectators will be able to experience a unique look and feel while watching specially highlighted sport actions. Events and concerts will become even more memorable with the playful lighting scenarios by Altis RGBW.

## BALANCED WHITE: DYNAMIC LIGHT FOR MAXIMUM FLEXIBILITY

Tune the colour temperature from the warmest 2700K all the way to 5700K and completely transform the atmosphere of your sports hall. During trainings, a warmer colour temperature of 3000K is preferred. While during competitions a cooler one, between 4000K and 5700K is needed. This can also vary from country to country as regulations change and, in some cases, certain requirements are specified by law. With Altis Balanced White you are able to adjust colour temperatures to suit the mood and requirements of the respective event, game, or match. Easily tune your sport with either DALI2 or DMX-RDM control.



### ALTIS RGBW



### ALTIS BALANCED WHITE



# CONTROL SOLUTIONS

## ADJUSTING LIGHT TO SUIT YOUR NEEDS

Altis is available in complete lighting management packages for wide-ranging professional and recreational sports applications, both indoors and outdoors. Designed to provide safety and comfort for players, our control solutions fully meet relevant sports lighting requirements. They also increase energy savings and provide more flexibility.

## FULLY INTEGRATED CONTROL PACKAGE

With the scalable control solution, Altis enables customisable, pre-programmed lighting effects with real-time overrides and supports Art-Net, DMX RDM and DALI protocols. The system's integrated lighting console also enables remote control of building management, audio and perimeter advertising systems.



Lighting playback controller with touch panel (in-or external)

### SERVICES:

- Commissioning and addressing
- Controls programming
- Web page creation with custom user interface design
- Integration of stand lighting control subsystems (DALI, DMX and hybrid)
- On-site technical consultation meetings
- Training of operating personnel
- Technical support
- Control solution for the entire stadium, from the pitch lighting to the facade and interiors

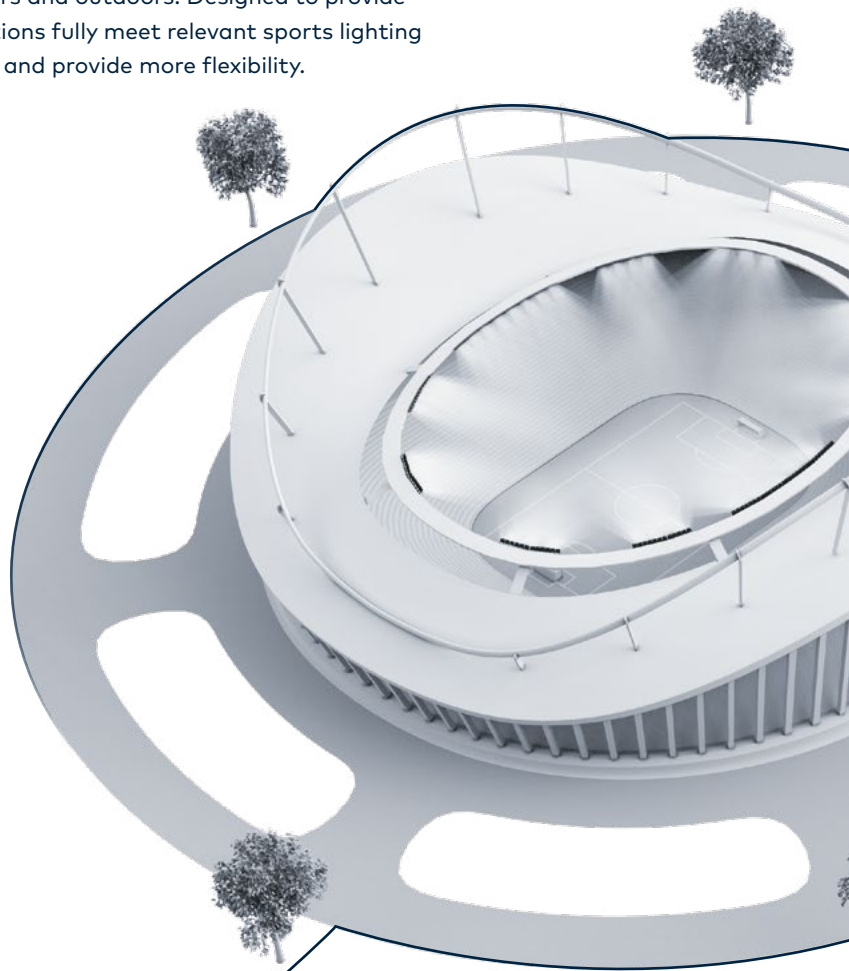



## BASIC CONTROL PACKAGE

Using a locally installed control cabinet, this switching and dimming package enables control of a group of lighting points, when needed. The solution offers good energy savings while still providing all of the required lighting on demand. Light settings can also be pre-programmed.

MATCH

TRAINING

CLEANING

ON/OFF

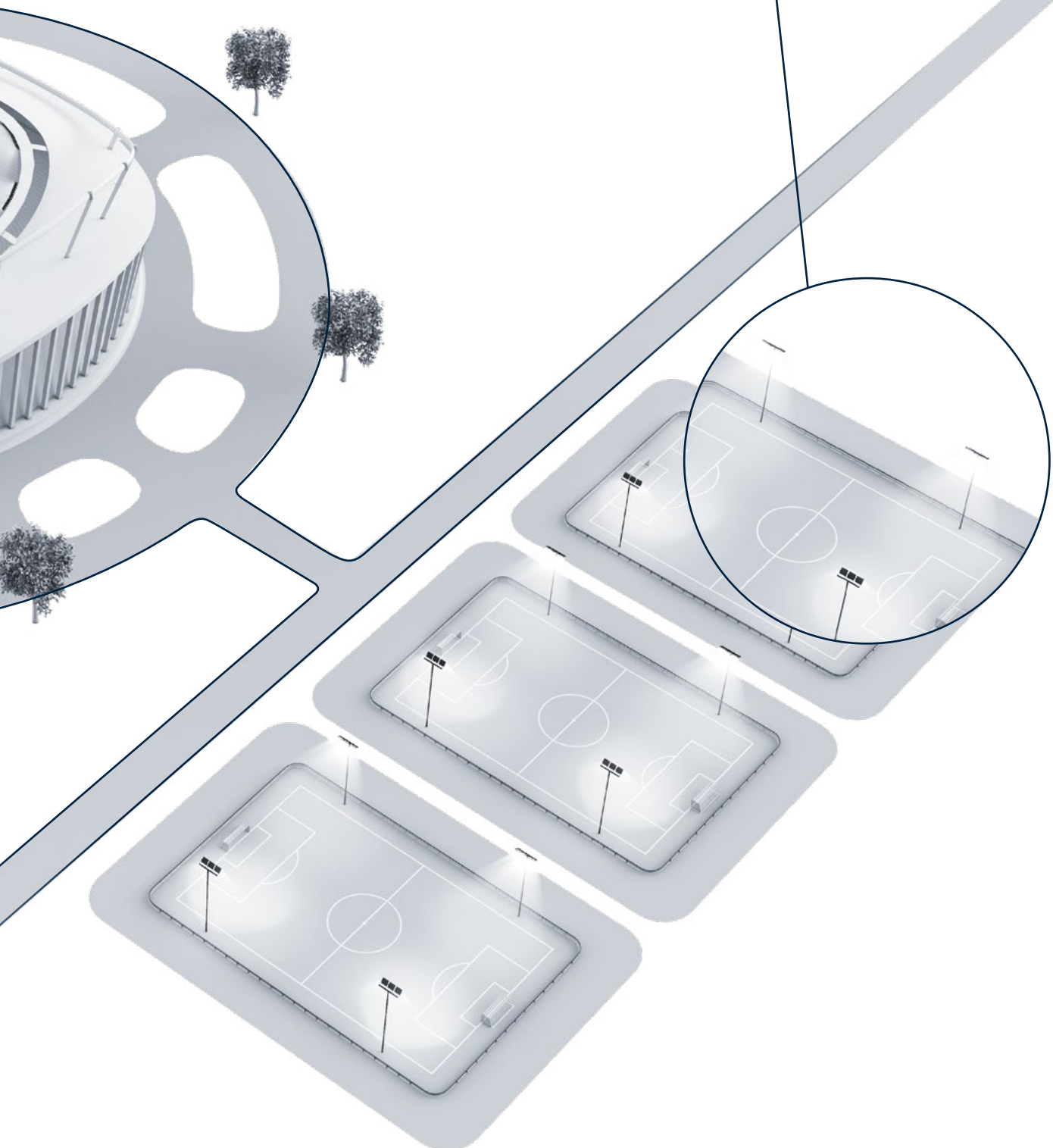

# INSTALLATION POSSIBILITIES

Altis can be configured for virtually any lighting design. Modules are easy to fixate for floodlight orientation and can be tilted with the angle indication. Post-top, surface and wall mounted options are also possible. The equally flexible gearbox IP66 enables installation directly in the back of the bracket, remotely up to 200 m, inside distribution boards, electrical rooms, on masts and more.

## MOUNTING OPTIONS

Direct lighting

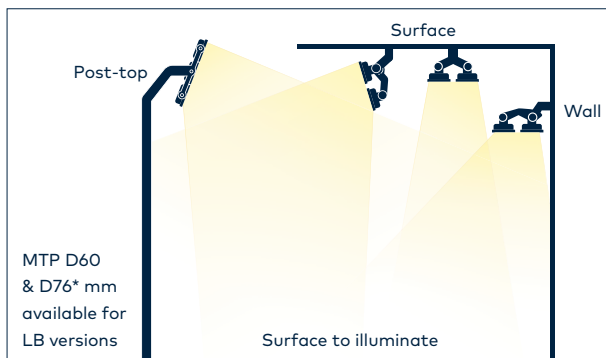

Indirect lighting

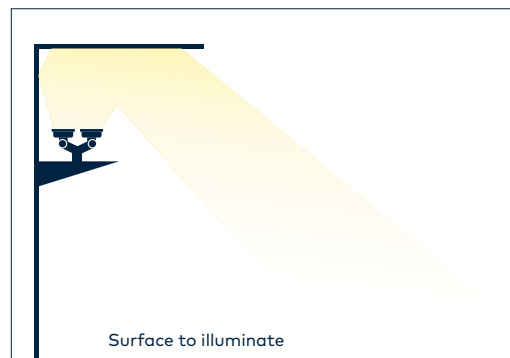

\*Post-top mounting adaptor (MTP D60/D76) to fit luminaire to Ø60 and to Ø76 mm column

## ROTATION OPTIONS

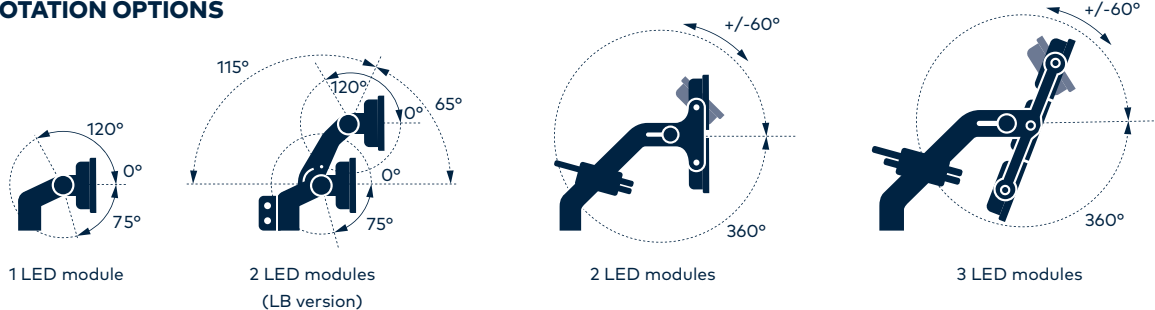

## ACCESSORIES



### AIMING DEVICE

To direct the orientation of the luminaire.

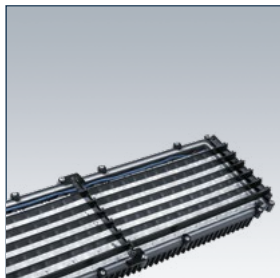

### LOUVRE

Internal or external louvre for asymmetric or symmetric optics to limit spill light.



### JUNCTION BOX

Allows the connection of different modules.



### DRIVER STIRRUP MOUNTING BRACKET

Enables gearbox mounting to the floodlight stirrup.

DISCOVER

# ALTIS

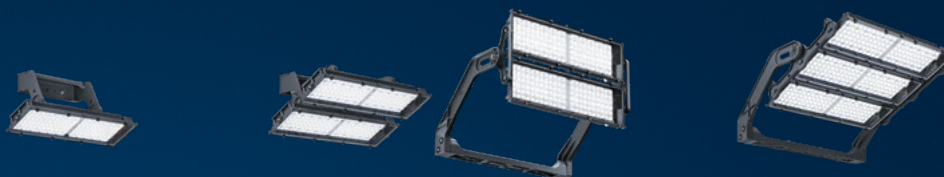

	132 LEDs 1 module	264 LEDs LB 2 modules	264 LEDs 2 modules	396 LEDs 3 modules
	Up to 61400* lm Up to 18 000* lm (RGBW) Up to 43 000* lm (Balanced White)	Up to 122799* lm Up to 36 000* lm (RGBW) Up to 96 000* lm (Balanced White)		Up to 184199* lm Up to 54 000* lm (RGBW) Up to 130 000* lm (Balanced White)
	Up to 155 lm/W			
	3000K / 4000K / 5700K / RGBW / Balanced White (2700K – 5700K)			
<b>CRI</b>	70 / 80 / 90			
<b>TLCI</b>	Up to 90+			
	IP66			
	-40 to +45°C			
	IK08			
	Ball proof			
	10 kV surge voltage protection			
	Max 9 kg Gearbox IP66: max 6.2 kg	Max 19 kg Gearbox IP66: max 6.2 kg	Max 22 kg Gearbox IP66: max 6.2 kg	Max 30.7 kg Gearbox IP66: max 6.2 kg
	Resistant to seaside and swimming pool environment (CLASS 5 – Very High)			
	Up to 100000h L90B10			
	Narrow beam / Medium beam / Wide beam / Elliptical beam / Asymmetrical 40° / Asymmetrical 50° / Asymmetrical 60° / Asymmetrical 60° Intense / Counter beam			
	0.07 at 0° / 0.08 at 15° / 0.09 at 45° / 0.13 at 65°	0.07 at 0° / 0.10 at 15° / 0.20 at 45° / 0.27 at 65°	0.158 at 0° / 0.187 at 15° / 0.339 at 45° / 0.446 at 65°	
	Luminaire: Texturized anthracite (different RAL on request) Gearbox: Texturized light grey			
	Flicker <1%			
	DALI2 / DMX RDM			

\*Data refers to system level, and to the narrow beam version



# CONFIGURATION GUIDE

## LUMINAIRE

ALTISLEDG3	264L	WB	857	LB	Rxxxx
Range	LED	Optic	CCT/CRI	Stirrup	Colour
				<b>LB</b>	Rxxxx RAL xxxx on request Light bracket 2 modules stirrup
			<b>730</b>		CRI 70 3000K
			<b>830</b>		CRI 80 3000K
			<b>740</b>		CRI 70 4000K
			<b>840</b>		CRI 80 4000K
			<b>757</b>		CRI 70 5700K
			<b>857</b>		CRI 80 5700K
			<b>957-T86</b>		CRI 90 5700K – TLCI 86
			<b>957-T90</b>		CRI 90 5700K – TLCI 90
			<b>RGBW MAX 850MA</b>		RED BLUE GREEN WHITE – it can be driven at maximum 850mA
			<b>BW</b>		BALANCED WHITE
		<b>NB</b>			Narrow beam
		<b>MB</b>			Medium beam
		<b>WB</b>			Wide beam
		<b>A4</b>			Asymmetric 40°
		<b>A5</b>			Asymmetric 50°
		<b>A6</b>			Asymmetric 60°
		<b>A6-I</b>			Asymmetrical 60° Intense
		<b>EB</b>			Elliptical beam
		<b>CB</b>			Counter beam
		<b>XxXxXx</b>			Mix of optics on request
	<b>396L</b>				396 LEDs (3 LED Modules)
	<b>264L</b>				264 LEDs (2 LED Modules)
	<b>132L</b>				132 LEDs (1 LED Module)
<b>ALTISLEDG3</b>	Altis				

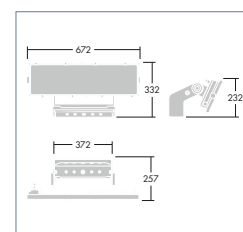

**ALTIS 132L**

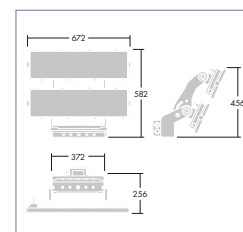

**ALTIS 264L LB**

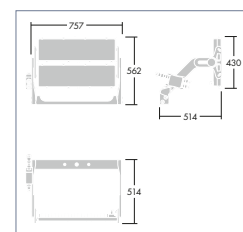

**ALTIS 264L**

## GEARBOX

ALTISLEDG3 GB	264L	85	200-400	DA
Range	Power	mA	Voltage	Controls
				<b>DA</b>
				<b>RDMX</b>
				DALI2 and autonomous dimming
				DMX RDM
			<b>120-277</b>	Voltage range
			<b>200-400</b>	Voltage range
		<b>120</b>		1200 mA*
		<b>105</b>		1050 mA*
		<b>85</b>		850 mA*
		<b>70</b>		700 mA*
		<b>55</b>		550 mA*
	<b>396L</b>			1500 W – 396 LEDs
	<b>264L</b>			1000 W – 264 LEDs
<b>ALTISLEDG3 GB</b>	Altis Gearbox			

\*The ambient temperature and the power rating have an influence on the useful lifetime of the luminaire.

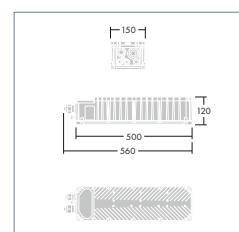

**ALTIS GEARBOX**

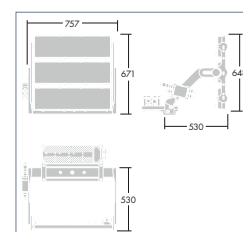

**ALTIS 396L**



As a globally leading luminaire manufacturer, Thorn Lighting provides a five-year warranty for its complete product range within all European Countries.  
thornlighting.com/guarantee

Thorn Lighting is constantly developing and improving its products. All descriptions, illustrations, drawings and specifications in this publication present only general particulars and shall not form part of any contract. The right is reserved to change specifications without prior notification or public announcement. All goods supplied by the company are supplied subject to the company's General Conditions of Sale, a copy of which is available on request. All measurements are in millimetres and weights in kilograms unless otherwise stated.  
02/2021 (INT)

**WE  
MAKE  
LIGHT  
WORK**