

Voyager Style

THORN

96636581 VOYAGER STYLE 150 CON E3T S WH

T_a -5 +30	IP20	IK03	CE	T_a 0 +35
-----------------	------	------	----	----------------

Voyager Style

Ultra slim LED escape sign luminaire; Luminaire with local battery supply for 3 h emergency lighting in maintained or non-maintained mode, with automatic test (auto-test) via the luminaire, display of luminaire status via status LED; non-maintained and maintained mode possible; display of luminaire status via status LED; housing made of polycarbonate ; luminaire easy to install; supplied with a set of ISO 7010 mountable direction signs (left, right, up, down and blank) for viewing from a maximum distance of 30 m; mounting of signs with discrete mounting pins; zero maintenance thanks to LED technology; service life of 50,000 h at constant luminous flux; uniform backlighting of pictogram; luminance > 500 cd/m² in the white region; Power supply: 220/240 V AC; Luminaire input power: 7.2 W; degree of protection: IP20, class of protection: Class II electrical; Impact strength: Impact strength: IK03; Dimensions: 341 x 37 x 334 mm; weight: 1.18 kg

Self-contained emergency luminaires rely on long-lasting batteries. Thorn batteries are robust and comes with a three-year guarantee (applicable subject to the terms and conditions of and to the extent as set forth in the manufacturer's guarantee on Thorn products, which shall be applicable analogously and which is available under http://www.thornlighting.com/en/products/5-year-guarantee/5-year-warranty/terms-of-guarantee_en.pdf. The battery guarantee shall not come into effect if the product has been installed later than three(3) months after delivery EXW (Incoterms 2010).



TLG_VYST_F_150_UP_CONTUS.jpg

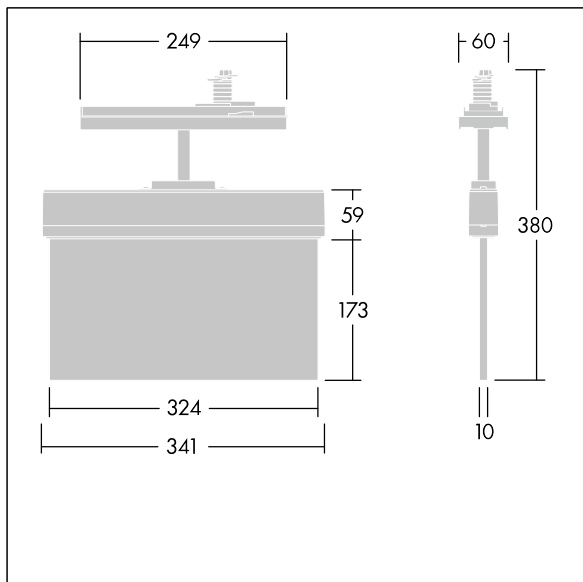

TLG_VYST_M_150_CONTUS.wmf

Los valores marcados con un * son valores de referencia. Los valores son aplicables para una temperatura ambiente de 25 °C, a no ser que se indique de otro modo.

Los productos de Thorn Lighting están sujetos a un continuo desarrollo. Nos reservamos el derecho de planificar en nuestros productos sin publicaciones técnicas ni otras modificaciones formales.

© Thorn Lighting